



Coimisiún na Scrúduithe Stáit
State Examinations Commission

Scéimeanna Marcála

Scrúduithe Ardteistiméireachta, 2005

*Innealtóireacht – Ábhair
Agus Teicneolaíocht*

Ardleibhéal

Marking Scheme

Leaving Certificate Examination, 2005

*Engineering – Materials
And Technology*

Higher Level



**Coimisiún na Scrúduithe Stáit
State Examinations Commission**

LEAVING CERTIFICATE EXAMINATION, 2005

ENGINEERING – MATERIALS AND TECHNOLOGY

(Higher level – 300 marks)

SAMPLE ANSWERS AND MARKING SCHEME

LEAVING CERTIFICATE ENGINEERING

MATERIALS AND TECHNOLOGY

(Higher Level – 300 marks)

Marking Scheme 2005

Answer Question 1, Sections A and B and Four other questions.

Question 1 Section A – 50 marks Any ten @ 5 marks each. (a) 3 + 2 (b) Any one @ 5 (c) 5 (d) 3 + 2 (e) 3 + 2 (f) 5 (g) 5 (h) Any two @ 3 + 2 (i) Any one @ 5 (j) 3 + 2 (k) 5 (l) 3 + 2 (m) Any one @ 5	Question 1 Section B – 50 marks Answer all of the following. (n) 10 (o) (i) Name 1 + 1 + 1 + 1 + 1 (ii) Any three @ 2 + 2 + 1 (p) Any two @ 5 + 5 (q) (i) 5 (ii) 5 (r) Any two @ 5 + 5	Question 2 – 50 marks (a) (i) 6 (ii) 6 (iii) 6 (b) Plot stress-strain diagram 8 (i) 4 (ii) 4 (c) (i) 8 (ii) 8
--	---	--

Question 3 – 50 marks (a) Any two @ 8 + 8 (b) (i) 14: (7 Regions @ 2 marks each) (ii) 2 + 2 (c) Any two @ 8 + 8	Question 4 – 50 marks (a) Any two @ 9 + 9 (b) (i) 5 (ii) 10: (5 labels @ 1 mark each) (5 descriptions @ 1 mark each) (iii) 3 (c) (i) 4 + 4 (ii) 6	Question 5 – 50 marks (a) Any one @ Describe 9 Diagram 9 (b) Any three @ 6 + 6 + 6 (c) (i) 7 (ii) 7 OR (c) (i) 7 (ii) 4 + 3
--	---	---

Question 6 – 50 marks (a) (i) Name 3 Operation 5 (ii) 4 (iii) 1 + 1 + 1 + 1 (b) Any two @ 9 + 9 (c) (i) 5 (ii) 5 (iii) 3 + 3	Question 7 – 50 marks (a) Any three @ 6 + 6 + 6 (b) (i) Any one @ 8 (ii) 4 + 4 (c) Any one @ 16 OR (c) Any two @ 8 + 8	Question 8 – 50 marks (a) Any one @ Operation 8 Application 8 (b) Any three @ 6 + 6 + 6 (c) 16 OR (c) (i) Identify 2 + 2 + 2 + 2 (ii) Operation 4 Application 4
---	--	---

End.

Question 1

(100 marks)

Section A – 50 marks

- (a) (i) Substitutional defect
(ii) Interstitial defect 3 + 2
- (b) **Heat sink:** This is a metal plate which radiates heat away from an electronic component, keeping its temperature low, thus preventing damage.
Breadboard: An electronic circuit may be assembled without soldering by plugging components into a breadboard. This facilitates pre-testing of circuits before final soldering. (Any one) 5
- (c) **Sacrificial protection** occurs when a reactive metal like zinc is placed in contact with a metal to be protected e.g. steel. The zinc becomes the anode and the steel the cathode. Corrosion occurs at the anode and this is sacrificed thus protecting the cathode. The anode has to be replaced from time to time. 5
- (d) **Safety factors** when using corrosives include:
- Use a mask and avoid inhalation
 - Avoid contact with the skin 3+2
- (e) **Systemic effects** of toxic materials include attacks on the central nervous system, the heart, respiratory system or circulatory system. These toxic materials can cause coma, convulsions, delirium and death. 3+2
- (f) **Allotropy** is the ability of a material to exist in more than one crystalline structure. Common examples include steel, which exists as BCC when cold and as FCC austenite when heated above its upper critical temperature, and carbon, which exists as graphite or as diamond under extremely high pressure. 5
- (g) **Magnetic separation:** Used in the separation of iron ore. The ore is passed over a rotating drum which has a fixed magnet inside. The iron ore, which is magnetic, is forced along the drum falling on one side of a separator, with the non-magnetic materials falling of the other side. 5

- (h) (i) **Drop forging:** G-clamps, spanners, crankshafts.
 (ii) **Calendering:** Packaging film, plastic sheets, upholstery material.
 (iii) **Casting:** bearings, vice, engine cylinders, toy soldiers. **(Any two) 3+2**

- (i) (i) Push button three port valve.
 (ii) Shuttle valve. **(Any one) 5**

- (j) **Ionic bond:** For an ionically bonded material an atom of one element gives an electron to an atom of another element. As a result one element consists of positive ions and the other of negative ions. Since unlike charged bodies attract, there is a force of attraction between the atoms forming an ionic bond. Sodium chloride is an example.

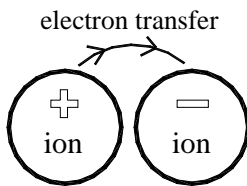

Metallic bond: Metals have atoms from which electrons are readily released. Positive ions are bonded together by a cloud of free electrons. These bonds are generally weaker than ionic.

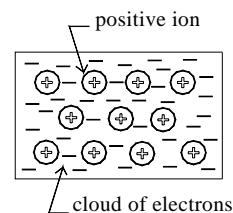

3+2

- (k) A **parison** is a heated plastic tube placed between two halves of a split mould in blow moulding. **5**

- (l) **Name:** castle nut with a split pin.

Application: Tightening wheel bearings to prevent nut ever coming loose. **3 + 2**

(m)

- (i) **Henry Maundslay:** In 1780 he used a revolving cutting tool to mill a slot in a lock. He mounted the tool on an arbour and set it up between centres on a lathe.

- (ii) **Simon Stevins:** A Flemish mathematician and engineer – he founded the science of hydrostatics, introduced **(1548 – 1620)**

decimal fractions laying the foundations for the decimal system of weights and measure. He developed methods of stopping invasions by designing sluice openings in dikes which could be opened and therefore flooding the lowlands.

- (iii) **Michael Faraday:** British physicist and chemist whose discoveries include electromagnetic induction and the laws of electrolysis. The unit of capacitance, the farad, is named after him.

(Any one) 5

Section B – 50 marks

- (n) Aero-generators convert the kinetic energy in the wind into mechanical power. This mechanical power is converted into electricity by a generator. An aero-generator has two or three aerodynamic blades, which, when pitched correctly against the wind, can rotate faster than the actual wind speed. This significant turning force is connected to a gearbox, which further increases the speed of rotation to a generator, thus generating electricity.

10

- (o) (i) **A:** Blade
B: Generator
C: Tower
D: Gearbox
E: Hub

(Name) 1 + 1 + 1 + 1 + 1

- (ii) **A – Blade:** The blades spin in the wind causing the main shaft to rotate.
B – Generator: The generator converts the mechanical energy from the rotor to electrical energy.
C – Tower: A conical or cylindrical steel structure which supports the nacelle and blades at the required height from the ground.
D – Gearbox: The gearbox increases the rotational speed from the blades and transmits a high speed rotation to the generator.
E – Hub: The blades are connected to the hub which is mounted onto a turning shaft. (Any three) 2 + 2 + 1

- (p) (i) A vibration sensor is included to ensure safety in extreme weather conditions. It consists of a ball sitting on a ring. The ball is connected to a switch by a chain. In cases of excessive vibration of the turbine, the ball falls from the ring and switches the aero-generator off.
- Braking systems are also built in to prevent blades from turning too fast.
- (ii) In a **pitch controlled** wind turbine, the power output of the turbine is constantly electronically checked. If the power output is too high a signal is sent to turn the rotor blades slightly out of the wind. This is reversed if the wind drops again. Hydraulics can be used to operate this system.
 In a **stall controlled** wind turbine, the rotor blades are bolted onto the hub at a fixed angle. The profile is aerodynamically designed to create a stall effect the moment the wind becomes too high. It creates a turbulence on the side of the rotor blade not facing the wind. This stall effect prevents the lifting force of the blades acting on the rotor. Approximately two thirds of wind turbines being installed in the world are stall controlled.
- (iii) The **nacelle** sits on top of the tower and houses the gearbox, the low and high speed shafts, generator, controller and brake. Some nacelles are large enough for a technician to stand inside. (Any two) 5 + 5

(q) (i) Reasons for installing large wind turbines:

- Large wind turbines are usually able to deliver electricity at lower cost.
- They are well suited to off-shore production.
- They act efficiently as a stand-alone unit on difficult terrain, where only one site is permissible.

5

(ii) Advantages of wind-generated electricity:

- Electricity generated without harmful emissions.
- Clean energy production.
- Renewable source.
- Safe and cheap.

3 + 2

(r)

(i) **Stall:** If the airflow can no longer flow smoothly across the wing

Stall

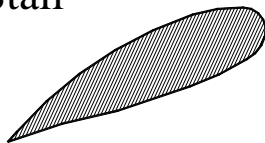

profile, a stall effect occurs. Here, the air loses contact with the rear side of the blade or profile, and a strong turbulence occurs causing lift to fall and an increase in drag.

(ii) **Lift:** If the air sliding along the upper surface of a wing profile moves

Lift ↑



faster than on the lower surface, lift will occur. The pressure will be lowest on the upper surface, causing a lifting force to pull upwards. The lift is perpendicular to the direction of the wind.

(iii) **Wind farm:** A group or site of wind turbines, which produce electricity to feed into the national grid.

(iv) **Anemometer:** This is a device for measuring wind speed and transmitting wind speed data to the controller.

(Any two) 5 + 5

Question 2

(50 marks)

- (a) (i) **Testing procedure:** An impact testing machine is shown in the diagram below. Impact testing tests for toughness. A striker / pendulum is released from a pre-determined height. It strikes and breaks the specimen. A pointer indicates the height of the follow through after breaking, thus determining the energy absorbed in breaking the specimen. **6**

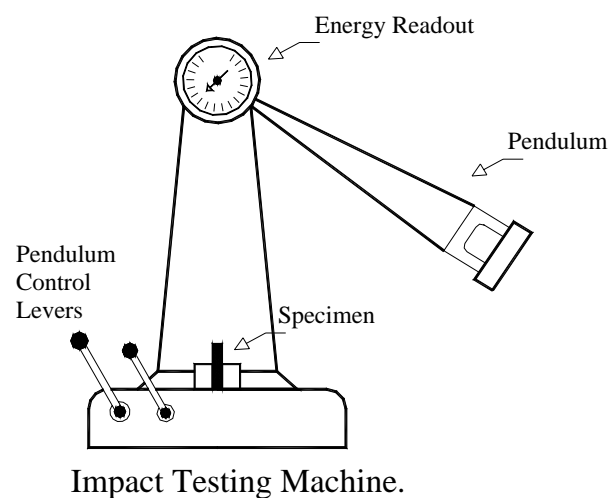

- (ii) **Izod method:**
- The specimen is held vertically, clamped at one end.
 - The notch is facing the pendulum.
 - The striking energy is 167 joules. **6**
- (iii) **Charpy method:**
- The specimen is held horizontally, clamped at both ends.
 - The notch is on the opposite side to the pendulum.
 - The striking energy is 300 joules. **6**

(b) Plot stress-strain graph.

8

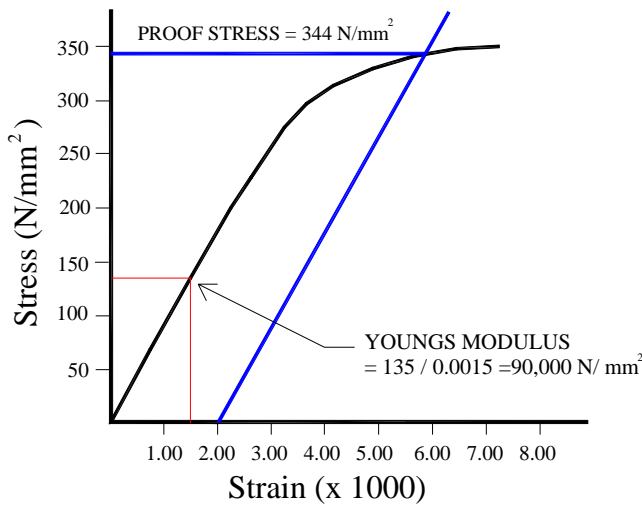

(i) **0.2% proof stress:**

From the graph the 0.2% proof stress is 344 N/mm²

4

(ii) **Youngs Modulus:**

$$\frac{\text{Stress}}{\text{Strain}} = \frac{135}{0.15} = 90 \text{ kN} / \text{mm}^2$$

4

(c) (i) **Eddy current testing:** When a coil, energised with high frequency alternating current, is placed close to a conductive material it will produce eddy currents in the material. These currents produce a magnetic field in the test specimen. A search coil, used in conjunction with the energised coil, can be connected to an electronic recording device.

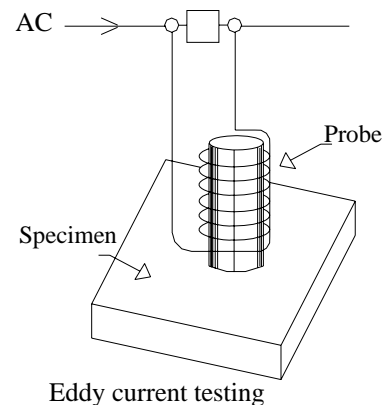

Any defect in the material distorts the magnetic field. This is indicated on the recording device. The magnitude of the distortion reflects the size of the defect. A suitable application is the detection of surface or subsurface flaws in nonferrous metals of uniform section.

8

- (ii) **X-ray testing:** Radiation from an x-ray tube is passed through the weld. If no defects are present, the amount of absorption is uniform across the area exposed to the x-ray beam. If a defect is present a smaller amount of rays is absorbed and there is a variation in the intensity of the emergent beam. This can be readily detected by placing a photographic film on the side of the material opposite the source of the radiation. On a negative film, the defect shows as a dark spot. A suitable application is the detection of internal flaws in welds.

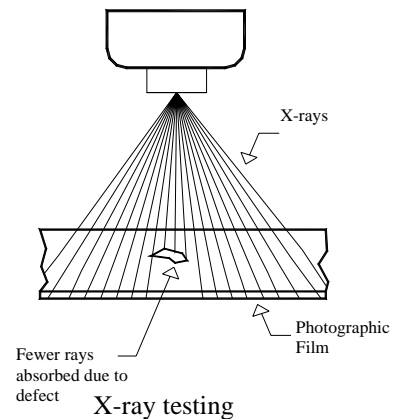

8

Question 3

(50 marks)

- (a) (i) **Eutectic:** This is a special change point where a liquid to solid change occurs. For steel this occurs at a temperature of 1140°C for the alloy with 4.3% carbon. Liquid changes directly to solid austenite and cementite.
Eutectoid: For steel, this reaction occurs during the solid state. Solid austenite changes to solid pearlite. This occurs at a temperature of 723°C for the alloy with 0.83% carbon.
- (ii) Methods used to measure furnace temp:
Optical pyrometer: The optical pyrometer compares the intensity of the Light coming from the filament of a lamp. The current flowing in the lamp is adjusted to match the light from the furnace using a variable resistance. When a colour match is obtained the lamp filament disappears and a temperature scale reading is taken.

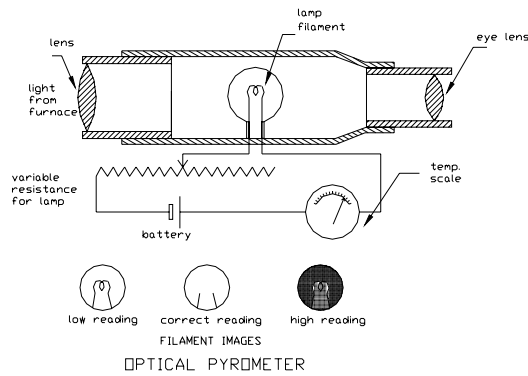

Thermo-electric pyrometer: If two dissimilar metals are joined together, with a Galvanometer placed in closed circuit at the open end, a rise in temperature of the joined end produces an electrical current which is recorded by the galvanometer. The galvanometer is calibrated to read in degrees of temperature instead of indicating electrical units.

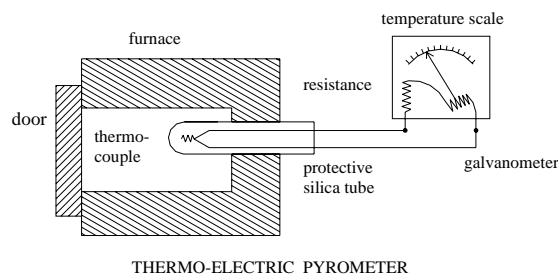

- Seager cones is another method employed.
- (iii) **Grey cast iron:** Forms due to slow cooling. Carbon is present as graphite flakes. Grey cast iron is soft, weak in tension, easy to machine. It has self lubricating and vibration dampening properties. It resists corrosion in many common engineering environments.
- White cast iron:** Forms under quick cooling conditions. The carbon is present in the form of ferrite and cementite. White cast iron is hard and brittle.
- (iv) **Recrystallisation:** This is where new crystals begin to grow from the distorted or dislocated nuclei formed during cold working. The component is heated as for annealing and as the temperature is increased, the new crystals grow until they have completely replaced the original distorted structure Degrees of hardness, tensile strength and percentage elongation all improve during recrystallisation.

(Any two) 8 + 8

- (b) (i) 1 – Austenite
 2 – Austenite and ferrite
 3 – Ferrite
 4 – Ferrite and pearlite
 5 – Pearlite
 6 – Pearlite and cementite
 7 – Austenite and cementite 7 × 2
- (ii) Region 3 – Diagram A
 Region 5 – Diagram B 2 + 2
- (c) (i) **Annealing:** This process fully softens the steel. The steel is heated to above its upper critical temperature. It is then allowed to “soak” in the furnace at this temperature. Cooling is controlled by, reducing the temperature of the furnace gradually.
- (ii) **Normalising:** Normalising removes internal stresses and refines abnormal grain structures which occur during hot or cold rolling and forging. The steel is heated to approximately 50°C above its upper critical temperature and allowed cool in air. This improves machinability.
- (iii) **Stress Relieving:** An annealing process which is carried out below the lower critical temperature of carbon steel. The component is heated and held at a specified temperature for a long period of time. It is cooled slowly, the temperature and time dependent on the component. This is used to relieve the build-up of internal stresses caused during cold working, thus reducing brittleness. (Any two) 8 + 8

Question 4

(50 marks)

- (a) (i) **Solvus line:** The transition line from one solid form to another solid form of an alloy is called the solvus line. Shown below are the solvus lines for the lead-tin alloy.

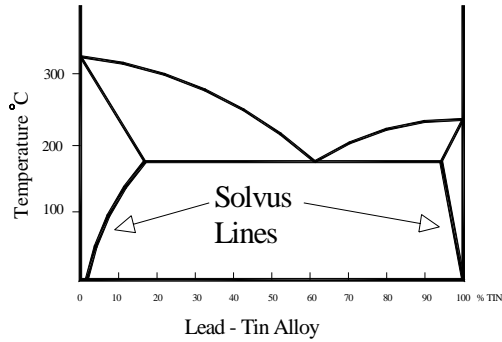

- (ii) **Simple eutectic solution:** The two alloying metals are completely soluble in the liquid state but insoluble in the solid state. On cooling two separate types of crystals or grains are formed. At one point, called the eutectic point, the liquid alloy changes directly to the solid state without any change in temperature.

- (iii) **Cooling curve:** If the temperature of a cooling molten metal is plotted against time a cooling curve results.

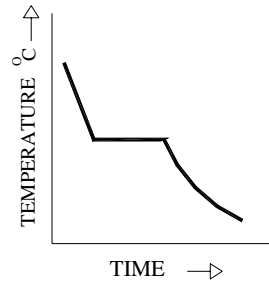

- (iv) The **latent heat of fusion** is the energy taken from, or given to, one kg of a substance when it changes from liquid to solid, or from solid to liquid, without any change in temperature.
- (v) **Substitutional solid solution:** When atoms of two materials of similar size

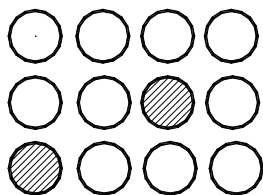

are completely soluble in each other in both the liquid and solid states. When the alloy solidified only one type of crystal is formed and it looks like a pure metal. The copper-nickel alloy is an example

(Any two) 9 + 9

(b) (i) Draw the equilibrium diagram:

5

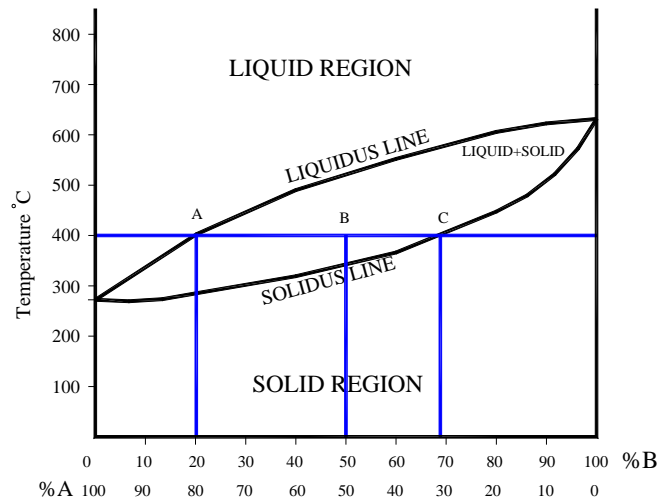

(ii) Label diagram:

(Labels) 5 x 1

Liquidus: For the alloy system this line represents the boundary between the fully liquid state and the beginning of solidification.

Solidus: The boundary line that determines the end of solidification. Below this line the alloy is completely solid.

Pasty Region: Between the liquidus and solidus line the alloy system is in a part liquid part solid state.

Liquid region: The two metals A and B are soluble in a liquid state.

Solid region: The two metals A and B are soluble in a solid state

(Describe) 5 x 1

(iii) The ratio of solid to liquid is determined by using the lever rule:

3

$$\frac{\text{Weight of solid}}{\text{Weight of liquid}} = \frac{AB}{BC} = \frac{30}{19}$$

(c) (i) A – Body centred cubic structure BCC

B – Face centred cubic structure FCC

4 + 4

(ii) An FCC structure has more closed packed atom layers than a BCC structure. Slip occurs along planes with the closest packing arrangement of its atoms. The ease of slip facilitates ductility.

6

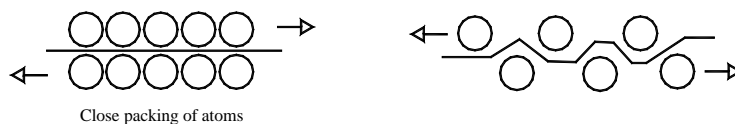

Question 5

(50 marks)

- (a) (i) **Electro-slag welding:** This automatic welding process is used to join thicker plates. The joint is placed vertically with a gap of up to 50mm between the square edges. The gap is filled with molten metal. Water cooled copper shoes are used on both sides of the plates, to prevent the molten metal escaping from the joint. The shoes are moved along the joint as the gap is being filled. The arc is struck between the electrode and a starter plate at the base of the joint. Flux in granular form is added and is melted by the arc. When the joint is filled with molten flux the arc is automatically extinguished and resistance heating in the molten slag bath occurs. The melted electrode and the parent metal fuse to form a weld pool which moves up along the joint.

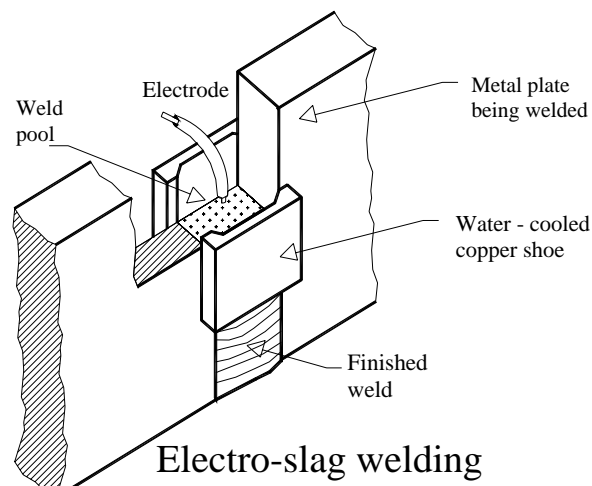

- (ii) **Seam-welding:** In seam welding copper disc electrodes are used to provide a continuous run of overlapping spot welds as the current is activated at set intervals. One of the electrodes may be driven by an electric motor. The work is moved between the rollers and pulses of current are supplied. Each pulse is set to last long enough to produce a spot weld. The time interval is controlled so that these spots overlap by approximately 40% of their length along the seam.

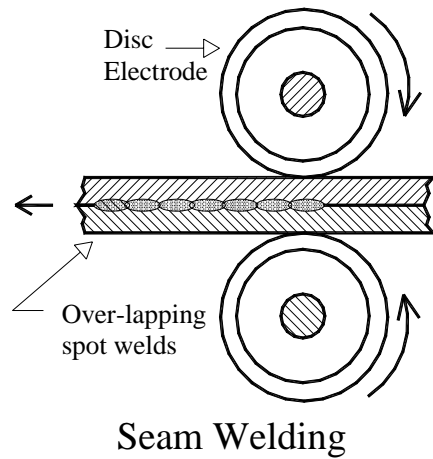

(Any one) Describe 9

Diagram 9

- (b) (i) **A** – Acetylene hose colour coded **red**.
B – Oxygen hose colour coded **blue**.
- (ii) **C** – **Working pressure gauge** giving a reading of the pressure from a particular cylinder.
or
Cylinder contents gauge showing the amount of oxygen or acetylene remaining in the cylinder.
D - **Pressure regulator** which controls the pressure of the oxygen or acetylene leaving the cylinder.
- (iii) Safety factors include:
- Oxygen should never be used instead of compressed air.
 - Special care is needed when using pressurised and flammable gases.
 - Use specified goggles to protect ones eyes from harmful light rays.
- (iv) Acetylene if directly compressed into a cylinder would explode under high pressure. Acetylene cylinders have to be packed with a porous material which is filled with acetone. Acetone is capable of absorbing up to 25 times its own volume of acetylene for each atmosphere of pressure applied to it. Dissolved acetylene is the name given to this form of acetylene fuel.

(v) **An oxidising flame:**

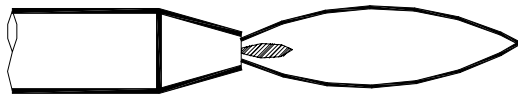

Oxidising Flame

- This flame contains excess oxygen, the ratio of oxygen to acetylene being 1.5 to 1.
- It has a working temperature of up to 3500°C.
- It is used to weld copper and brass but not steel as it would oxidise and contaminate the joint.

A carburising flame:



Carburising Flame

- This flame contains excess acetylene, the ratio of oxygen to acetylene being 0.9 to 1.
- It has a working temperature of approximately 3150°C.
- It is used to weld aluminium, special alloy steel and gives excellent protection against oxidation.

(Any three) 6 + 6 + 6

- (c) (i) **Bridge rectifier:** This is used to supply direct current when arc welding. The voltage is rectified by using the rectifier which consists of four diodes. **7**
- (ii) **Transformer:** A transformer is used to step down the mains voltage to a suitable level for arc welding. **7**

OR

- (c) (i) Resistance spot welding
Resistance seam welding
Mags welding **7**
- (ii) Light gauge assembly work
Car manufacture **4 + 3**

Question 6**(50 marks)**

(a) (i) **Name:** Extrusion **3**

Principle of operation: The thermoplastic moulding powder is fed from a hopper to a heated compartment. A large archimedian screw moves the softening plastic along the compartment. The plastic is forced through a die at the end of the machine. The die gives the desired extruded shape, which is cooled by air or water and cut into specific lengths. **5**

(ii) **Component produced:**

- Piping
- Railing
- Long shapes of regular cross section **4**

(iii) **A – Screw. B – Hopper. C – Heater. D – Die.** **1 + 1 + 1 + 1**

(b) (i) **Thermoplastic:**

- Bonded by weak van-der-waals forces between adjacent chains.
- Internal structure can be linear or branched.
- They are soft, flexible and can be re-softened repeatedly using heat and pressure.

Thermosetting:

- Primary covalent bonding giving 3-D structure.
- Internal structure is cross-linked.
- They are rigid, strong, inflexible and cannot be remoulded. High melting point.

(ii) **Crystalline polymer:** The structure is arranged in a regular geometrical pattern. This gives a strong rigid 3-dimensional structure with high tensile strength and melting point, as in thermosetting plastics.

Amorphous polymer: Here the chain structure is random and disorganised. This structure has a lower tensile strength and melting point.

(iii) **Natural rubber:** This is the sap from the rubber tree. Its polymer chains are of a folded nature and are bonded by weak van-der-waals forces. Natural rubber is both plastic and elastic.

Synthetic rubber: This is natural rubber processed with sulphur, which produces cross-links between the folded chains. The process is called vulcanisation. This gives a stronger bond which is more durable and less flexible than natural rubber.

(iv) **Condensation polymer:** Condensation polymerisation is used to produce many thermosetting plastics. Two molecules are condensed into one small molecule and usually water is eliminated every time a monomer unit is added to the chain. This forms a strong primary bond with cross-links between the chains. The resulting polymer cannot be re-softened and has a high tensile strength and melting point. Phenol Formaldehyde is a common example.

Co-polymer: This is a polymer formed when two different mers are linked together in the same polymer chain. This new polymer may have a mixture of new improved properties. Co-polymers are similar to alloying in metals.

(Any two) 9 + 9

(c) (i) Cross-linked. **5**

(ii) Primary covalent bonding, forming a strong rigid 3-D structure. **5**

(iii) Properties include:

- High melting point
- High tensile strength
- Inflexible
- Can't be remoulded

3 + 3

Question 7

(50 marks)

- (a) (i) **Countersinking** is the enlarging of the mouths of holes to accommodate countersunk head screws and rivets.
Counterboring is the increasing of the hole diameter to a certain depth in order to accommodate cheese head or round head screws.
- (ii) Safety hazards include:
- Continual contact with cutting fluids can cause the skin to swell, crack, and bleed.
 - Contact with mineral oils can cause skin cancer.
 - Frequent contact with water based emulsions could lead to dermatitis.
- (iii) Factors influencing surface finish:
- Use of cutting fluids or coolants.
 - Workpiece material.
 - Cutting speed.
 - Sharp well supported cutting tool.
- (iv) The **bond** is the substance which holds the abrasive grains together. The bonding material and the abrasive grains can be shaped to the desired form of grinding wheel.
- (v) **Orthogonal cutting** has two forces, the tangential force and the axial force, acting on the cutting tool.
Oblique cutting consists of a three force system. A third force is called the radial force. This force is caused by the plan approach angle on the cutting tool. The axial force decreases as the radial force increases.
- (Any three) 6 + 6 + 6**
- (b) (i) The gauge on the left is called a **plug gauge**. Its **function** is to accurately determine if a selected hole is within a specific range of limits.

The gauge on the right is called a **gap gauge**. Its **function** is to accurately check if an external diameter is within a specific range of limits.

(Any one) 8

(ii)

- Burrs or scratching on precision equipment.
- Human error.
- Straining or rough usage of precision equipment.

4 + 4

(c) (i) In **up-cut milling** the milling cutter is rotating against the direction of the workpiece. This is the more common method used in milling. Correct clamping of the workpiece is essential.

In **down-cut milling** the cutter rotation is in the same direction as the workpiece movement. This can lead to the cutter climbing the work. Machines that have been fitted with backlash eliminator are suitable for down-cut milling. An advantage with this method occurs when taking heavier cuts, as the pressure is directed downwards and there is no lifting tendency.

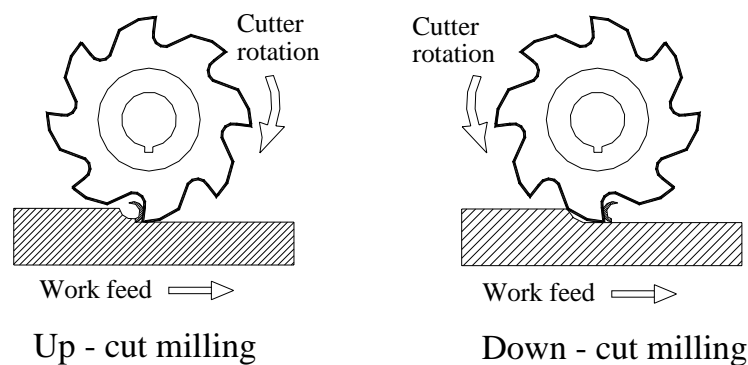

(ii) **Peripheral milling:** In peripheral milling the finished surface is produced from the cutting action of teeth on the periphery of the milling cutter. Sometimes referred to as slab milling when a long cylindrical cutter is used. Up cut and down cut milling are other examples of peripheral milling. Cutters are mounted on an arbour.

Face milling: In face milling the milling cutter operates at right angles to the surface being generated. The face or end of the cutter generates the desired surface on the workpiece. Many of the cutters are chuck mounted.

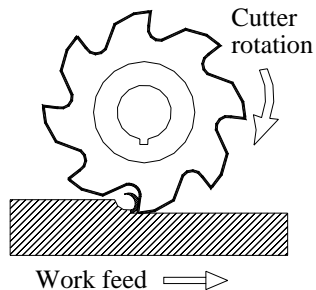

Peripheral milling

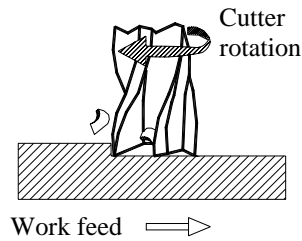

Face milling

(Any one) 16

OR

- (c) (i) **Safety features** incorporated in a CNC lathe:
- Fuses used to prevent circuit overload.
 - Machine will not operate if chuck guard is up.
 - Emergency stop button.
 - Simulation of machining operation available.
 - Clear machine guards.
- (ii) **G-codes** control the cutting tool movement. G00 denotes rapid movement and G01 denotes cutting in a straight line.
M-codes cover a variety of operational functions e.g. M04 starts the spindle in reverse, M30 end of program, M06 pause program to change cutting tool.
- (iii) In **conventional machining** the tool is moved by an operator either manually or using the automatic feed mechanism. The operator also performs all other operational actions e.g. starting and stopping the spindle, changing speeds or feed rates. These actions have to be repeated each time even if an identical component is being produced.

Computer numerical control machining is much more suited to large batch repetitive production. It gives higher levels of productivity with uniformity of end product. There is much less operator involvement in the process which improves quality control and reduces costs. Machining in two or three axes can occur, which allows for more elaborate contours and shapes.

(Any two) 8 + 8

Question 8

(50 marks)

- (a) (i) **Operation:** Bell-crank mechanism

Application: Bicycle brakes

- (ii) **Operation:** Ratchet and pawl mechanism

Application: Used in wire tensioning devices e.g. tennis nets.

(Operation) 8

(Application) 8

- (b) (i) A **capacitor** is used to store electrical charge, and will discharge through a circuit so that the benefit of the stored charge is effective.

- (ii) A **non-return** valve is a mechanism which will only allow the flow of air or liquid through it in one direction. It prevents liquid or gas from flowing back.

- (iii) An **idler gear** ensures that the driver and the driven gear have the same rotational direction. It has no effect on the speeds between them.

- (iv) **Dividing head:** This is used when machining around the periphery of a component e.g. splines on shafts. It is used to index the component accurately so that it may be machined the required number of times.

- (v) **Solar panel:** This is used to harness the sun's rays and using them to generate electrical energy or to provide hot water and heating for buildings.

(Any three) 6 + 6 + 6

- (c) **A Quick return mechanism:** is used on a shaping machine, to return the ram on the idle stroke at a faster speed than the cutting stroke. As the bull wheel rotates, the crank pin causes the slotted link to move the ram back and forth. The working stroke is produced when the crank pin rotates through arc "ABC" and the shorter idle stroke is produced as it rotates through arc "CA". The position of the crank pin can be adjusted by a lead screw which is rotated by level gears. The length of the ram stroke is reduced, if the crank pin is nearer the centre of the bull wheel. See diagram below.

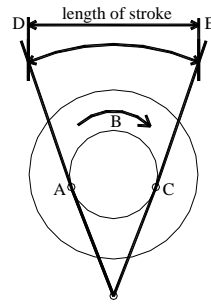
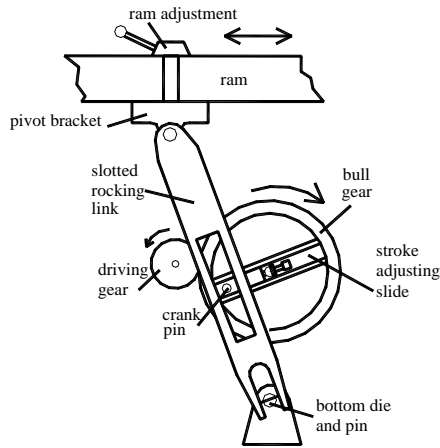

In passing through the arc "ABC" the crank pin produces the working stroke "DE". It produces the idle (return) stroke through arc "AC".

Slider crank mechanism:

Function: A crank and slider mechanism changes rotary to reciprocal motion or vice-versa.

Operation: In the car engine the reciprocating motion of the piston caused by exploding fuel is converted into rotary motion as the con-rod moves the crankshaft around. An air compressor uses this principal in reverse an electric motor turns the crankshaft and the piston moves up and down to compress the air.

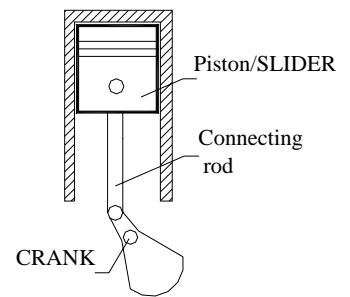

16

OR

(c) (i) **A:** Light dependent resistor

B: Diode

C: Motor

D: Transistor

2 + 2 + 2 + 2

(ii) **Operation:** The circuit uses a relay to power a large voltage circuit from a smaller powered circuit. In the daytime the LDR has a very low resistance and the voltage across it is low. Therefore the voltage across transistor D is very low. No current can pass across the base / emitter junction and the motor is off. If the LDR is covered or in darkness its resistance increases, the voltage across the base / emitter rises and the transistor begins to conduct therefore energising the relay. The relay in turn operates the motor. **4**

Application: Switching a motor when darkness is sensed by the LDR. **4**